

SWITCHMODE™ Schottky Power Rectifier

The SWITCHMODE Power Rectifier employs the Schottky Barrier principle in a large area metal-to-silicon power diode. State-of-the-art geometry features epitaxial construction with oxide passivation and metal overlay contact. Ideally suited for use as rectifiers in very low-voltage, high-frequency switching power supplies, free wheeling diodes and polarity protection diodes.

- Highly Stable Oxide Passivated Junction
- Very Low Forward Voltage Drop
- High Junction Temperature Capability
- High dv/dt Capability
- Excellent Ability to Withstand Reverse Avalanche Energy Transients
- Guardring for Stress Protection
- Epoxy Meets UL94, VO at 1/8"
- Electrically Isolated. No Isolation Hardware Required.
- UL Recognized File #E69369(1)

Mechanical Characteristics

- Case: Epoxy, Molded
- Weight: 1.9 grams (approximately)
- Finish: All External Surfaces Corrosion Resistant and Terminal Leads are Readily Solderable
- Lead Temperature for Soldering Purposes: 260°C Max. for 10 Seconds
- Shipped 50 units per plastic tube
- Marking: B1045

MAXIMUM RATINGS

Rating	Symbol	Value	Unit
Peak Repetitive Reverse Voltage Working Peak Reverse Voltage DC Blocking Voltage	V_{RRM} V_{RWM} V_R	45	Volts
Average Rectified Forward Current (Rated V_R), $T_C = 135^\circ\text{C}$	$I_{F(AV)}$	10	Amps
Peak Repetitive Forward Current (Rated V_R , Square Wave, 20 kHz), $T_C = 135^\circ\text{C}$	I_{FRM}	20	Amps
Non-repetitive Peak Surge Current (Surge applied at rated load conditions halfwave, single phase, 60 Hz)	I_{FSM}	150	Amps
Peak Repetitive Reverse Surge Current (2.0 μs , 1.0 kHz) Figure 6	I_{RRM}	1.0	Amp
Operating Junction and Storage Temperature	T_J, T_{stg}	-65 to +150	$^\circ\text{C}$
Voltage Rate of Change (Rated V_R)	dv/dt	10000	V/ μs
RMS Isolation Voltage (t = 1 second, R.H. \leq 30%, $T_A = 25^\circ\text{C}$)(2)	Per Figure 8 Per Figure 9(1) Per Figure 10	V_{iso1} V_{iso2} V_{iso3}	4500 3500 1500 Volts

THERMAL CHARACTERISTICS

Maximum Thermal Resistance, Junction to Case	$R_{\theta JC}$	4.0	$^\circ\text{C/W}$
Lead Temperature for Soldering Purposes: 1/8" from Case for 5 seconds	T_L	260	$^\circ\text{C}$

- (1) UL Recognized mounting method is per Figure 9.
(2) Proper strike and creepage distance must be provided.

SWITCHMODE is a trademark of Motorola, Inc.

Preferred devices are Motorola recommended choices for future use and best overall value.

MBRF1045

Motorola Preferred Device

**SCHOTTKY BARRIER
RECTIFIER
10 AMPERES
45 VOLTS**

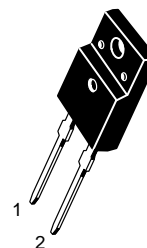

**CASE 221E-01
ISOLATED TO-220**



MBRF1045

ELECTRICAL CHARACTERISTICS

Characteristic	Symbol	Max	Unit
Maximum Instantaneous Forward Voltage (3) ($i_F = 20$ Amp, $T_C = 25^\circ\text{C}$) ($i_F = 20$ Amp, $T_C = 125^\circ\text{C}$) ($i_F = 10$ Amp, $T_C = 125^\circ\text{C}$)	v_F	0.84 0.72 0.57	Volts
Maximum Instantaneous Reverse Current (3) (Rated DC Voltage, $T_C = 25^\circ\text{C}$) (Rated DC Voltage, $T_C = 125^\circ\text{C}$)	i_R	0.1 15	mA

(3) Pulse Test: Pulse Width = 300 μs , Duty Cycle $\leq 2.0\%$

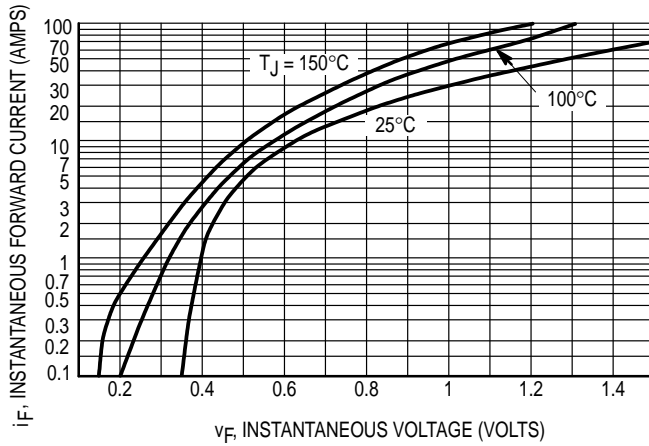

Figure 1. Maximum Forward Voltage

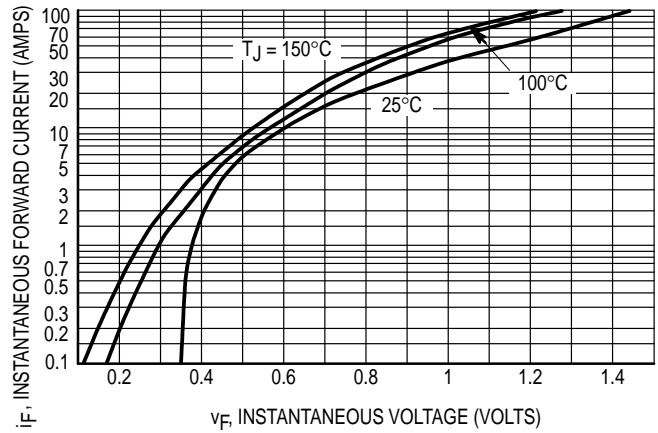

Figure 2. Typical Forward Voltage

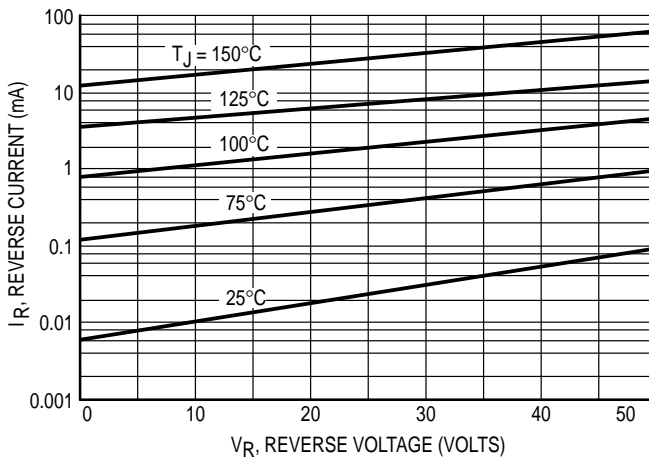

Figure 3. Maximum Reverse Current

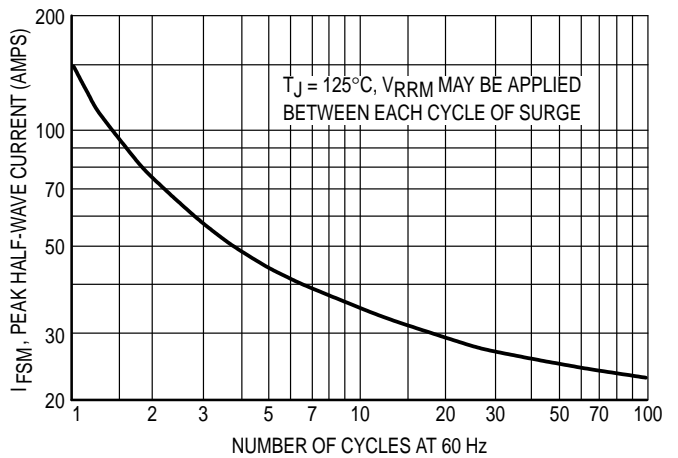

Figure 4. Maximum Surge Capability

HIGH FREQUENCY OPERATION

Since current flow in a Schottky rectifier is the result of majority carrier conduction, it is not subject to junction diode forward and reverse recovery transients due to minority carrier injection and stored charge. Satisfactory circuit analysis work may be performed by using a model consisting of an ideal diode in parallel with a variable capacitance. (See Figure 5.)

Rectification efficiency measurements show that operation will be satisfactory up to several megahertz. For example, relative waveform rectification efficiency is approximately 70 percent at 2.0 MHz, e.g., the ratio of dc power to RMS power in the load is 0.28 at this frequency, whereas perfect rectification would yield 0.406 for sine wave inputs. However, in contrast to ordinary junction diodes, the loss in waveform efficiency is not indicative of power loss; it is simply a result of reverse current flow through the diode capacitance, which lowers the dc output voltage.

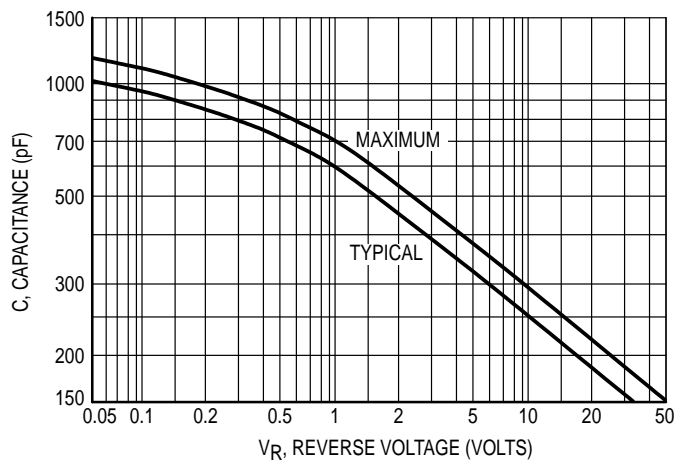

Figure 5. Capacitance

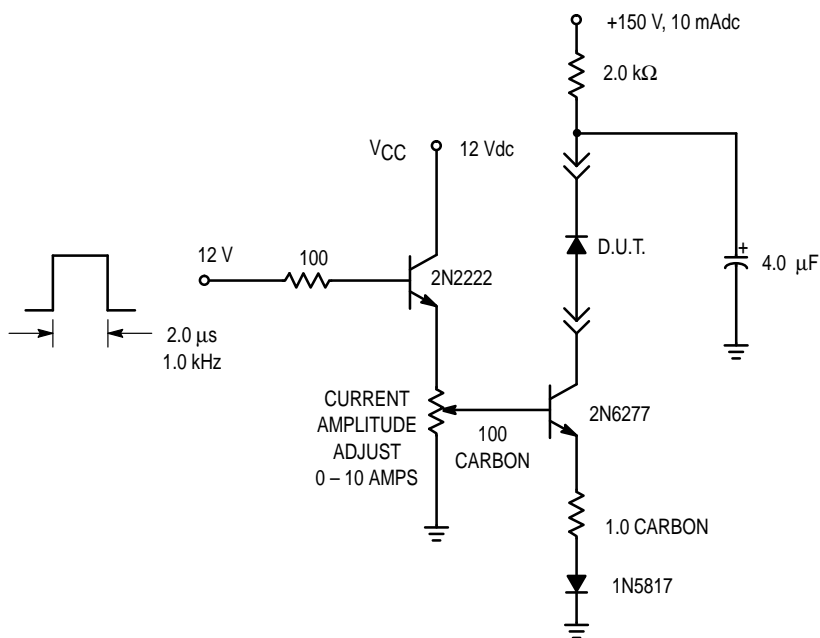

Figure 6. Test Circuit for dv/dt and Reverse Surge Current

TEST CONDITIONS FOR ISOLATION TESTS*

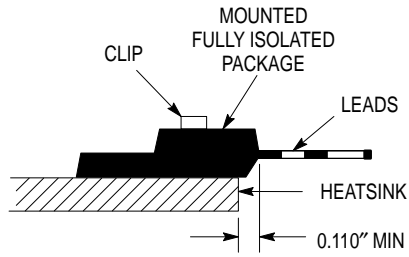

Figure 7. Clip Mounting Position for Isolation Test Number 1

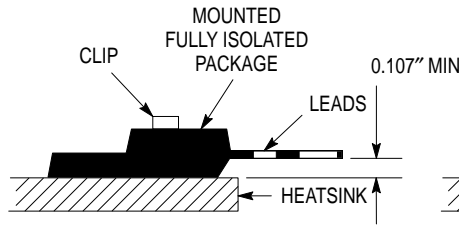

Figure 8. Clip Mounting Position for Isolation Test Number 2

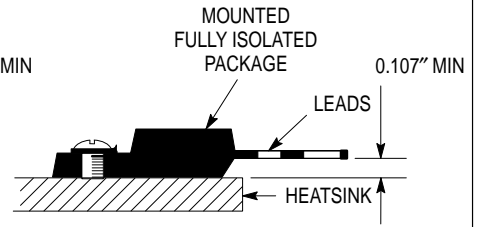
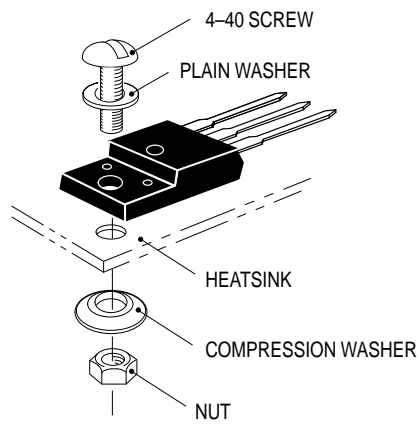

Figure 9. Screw Mounting Position for Isolation Test Number 3

* Measurement made between leads and heatsink with all leads shorted together.

MOUNTING INFORMATION**



10a. Screw-Mounted

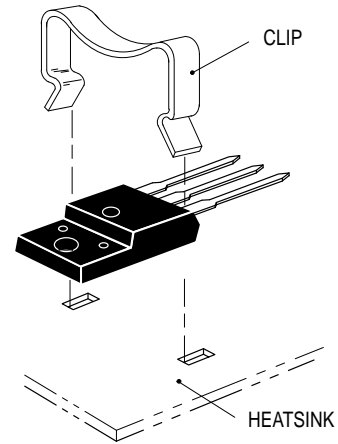

10b. Clip-Mounted

Figure 10. Typical Mounting Techniques

Laboratory tests on a limited number of samples indicate, when using the screw and compression washer mounting technique, a screw torque of 6 to 8 in · lbs is sufficient to provide maximum power dissipation capability. The compression washer helps to maintain a constant pressure on the package over time and during large temperature excursions.

Destructive laboratory tests show that using a hex head 4-40 screw, without washers, and applying a torque in excess of 20 in · lbs will cause the plastic to crack around the mounting hole, resulting in a loss of isolation capability.

Additional tests on slotted 4-40 screws indicate that the screw slot fails between 15 to 20 in · lbs without adversely affecting the package. However, in order to positively ensure the package integrity of the fully isolated device, Motorola does not recommend exceeding 10 in · lbs of mounting torque under any mounting conditions.

**For more information about mounting power semiconductors see Application Note AN1040.

PACKAGE DIMENSIONS

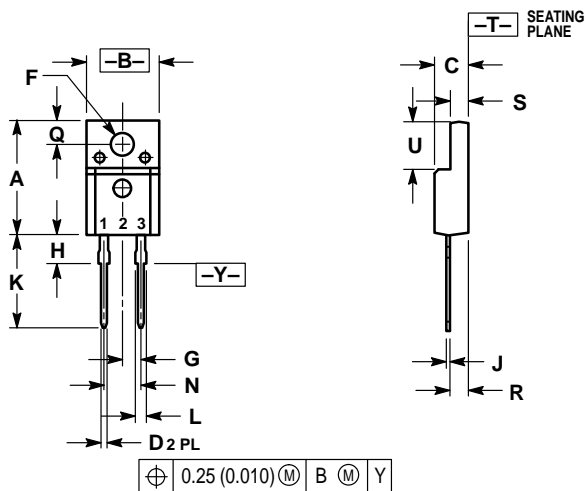

- NOTES:
 1. DIMENSIONING AND TOLERANCING PER ANSI Y14.5M, 1982.
 2. CONTROLLING DIMENSION: INCH.

DIM	INCHES		MILLIMETERS	
	MIN	MAX	MIN	MAX
A	0.621	0.629	15.78	15.97
B	0.394	0.402	10.01	10.21
C	0.181	0.189	4.60	4.80
D	0.026	0.034	0.67	0.86
F	0.121	0.129	3.08	3.27
G	0.100 BSC		2.54 BSC	
H	0.123	0.129	3.13	3.27
J	0.018	0.025	0.46	0.64
K	0.500	0.562	12.70	14.27
L	0.045	0.060	1.14	1.52
N	0.200 BSC		5.08 BSC	
Q	0.126	0.134	3.21	3.40
R	0.107	0.111	2.72	2.81
S	0.096	0.104	2.44	2.64
U	0.259	0.267	6.58	6.78

STYLE 1:
 PIN 1. CATHODE
 2. N/A
 3. ANODE

CASE 221E-01
 ISSUE O

Motorola reserves the right to make changes without further notice to any products herein. Motorola makes no warranty, representation or guarantee regarding the suitability of its products for any particular purpose, nor does Motorola assume any liability arising out of the application or use of any product or circuit, and specifically disclaims any and all liability, including without limitation consequential or incidental damages. "Typical" parameters which may be provided in Motorola data sheets and/or specifications can and do vary in different applications and actual performance may vary over time. All operating parameters, including "Typicals" must be validated for each customer application by customer's technical experts. Motorola does not convey any license under its patent rights nor the rights of others. Motorola products are not designed, intended, or authorized for use as components in systems intended for surgical implant into the body, or other applications intended to support or sustain life, or for any other application in which the failure of the Motorola product could create a situation where personal injury or death may occur. Should Buyer purchase or use Motorola products for any such unintended or unauthorized application, Buyer shall indemnify and hold Motorola and its officers, employees, subsidiaries, affiliates, and distributors harmless against all claims, costs, damages, and expenses, and reasonable attorney fees arising out of, directly or indirectly, any claim of personal injury or death associated with such unintended or unauthorized use, even if such claim alleges that Motorola was negligent regarding the design or manufacture of the part. Motorola and  are registered trademarks of Motorola, Inc. Motorola, Inc. is an Equal Opportunity/Affirmative Action Employer.

Mfax is a trademark of Motorola, Inc.

How to reach us:

USA/EUROPE/Locations Not Listed: Motorola Literature Distribution;
P.O. Box 5405, Denver, Colorado 80217. 303-675-2140 or 1-800-441-2447

JAPAN: Nippon Motorola Ltd.; Tatsumi-SPD-JLDC, 6F Seibu-Butsuryu-Center,
3-14-2 Tatsumi Koto-Ku, Tokyo 135, Japan. 81-3-3521-8315

Mfax™: RMFAX0@email.sps.mot.com – TOUCHTONE 602-244-6609
INTERNET: <http://Design-NET.com>

ASIA/PACIFIC: Motorola Semiconductors H.K. Ltd.; 8B Tai Ping Industrial Park,
51 Ting Kok Road, Tai Po, N.T., Hong Kong. 852-26629298



This datasheet has been download from:

www.datasheetcatalog.com

Datasheets for electronics components.